

GROUP C
CLUTCH - Flywheel and Drive Plate

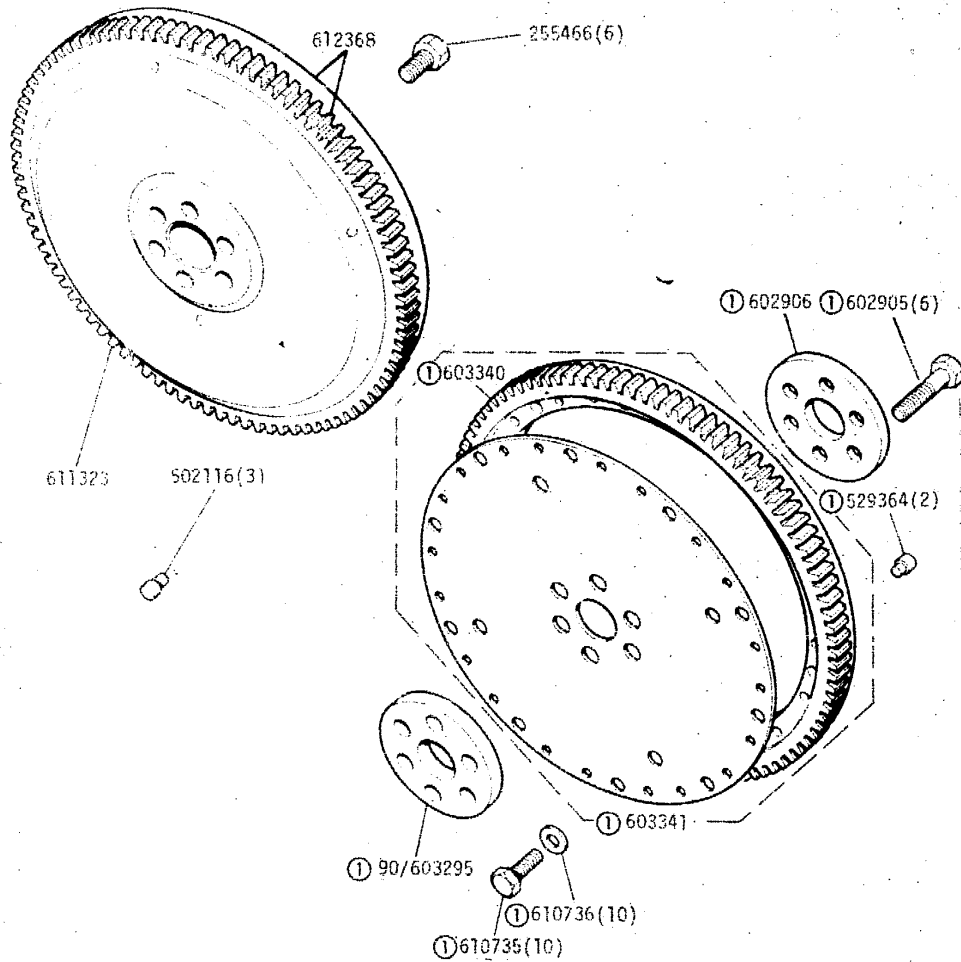

① AUTO

TR8

1D 02L

B7013/2

GROUP C
CLUTCH - Clutch Cover and Plate

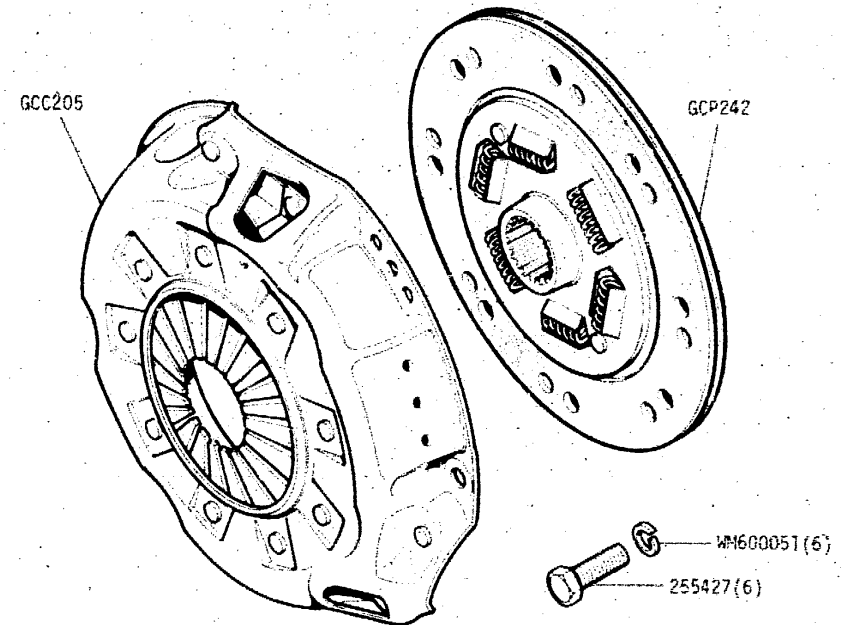

TR8

1D 02R

B7041/1

GROUP INDEX

Introduction **1B 2B**
 Engine **1C**
 Flywheel and Clutch **1D**
 Gearbox and Propshaft **1E**
 Axles, Suspension, Drive Shafts, Wheels **1F**

Steering **1G**
 Brakes and Brake Controls **1H**
 Fuel, Exhaust and Emission Systems **1I - J**
 Cooling, Heating and Air Conditioning **1K**
 Electrical, Washers-Wipers, Instruments **1L-M**

Chassis, Subframes, Bodyshell, Fittings **2C**
 Fascia, Trim, Seats and Fixings **2D**
 Miscellaneous **2E**
 Numerical Index **2F**

1D02

GROUP C
CLUTCH - Clutch Housing and Release Mechanism

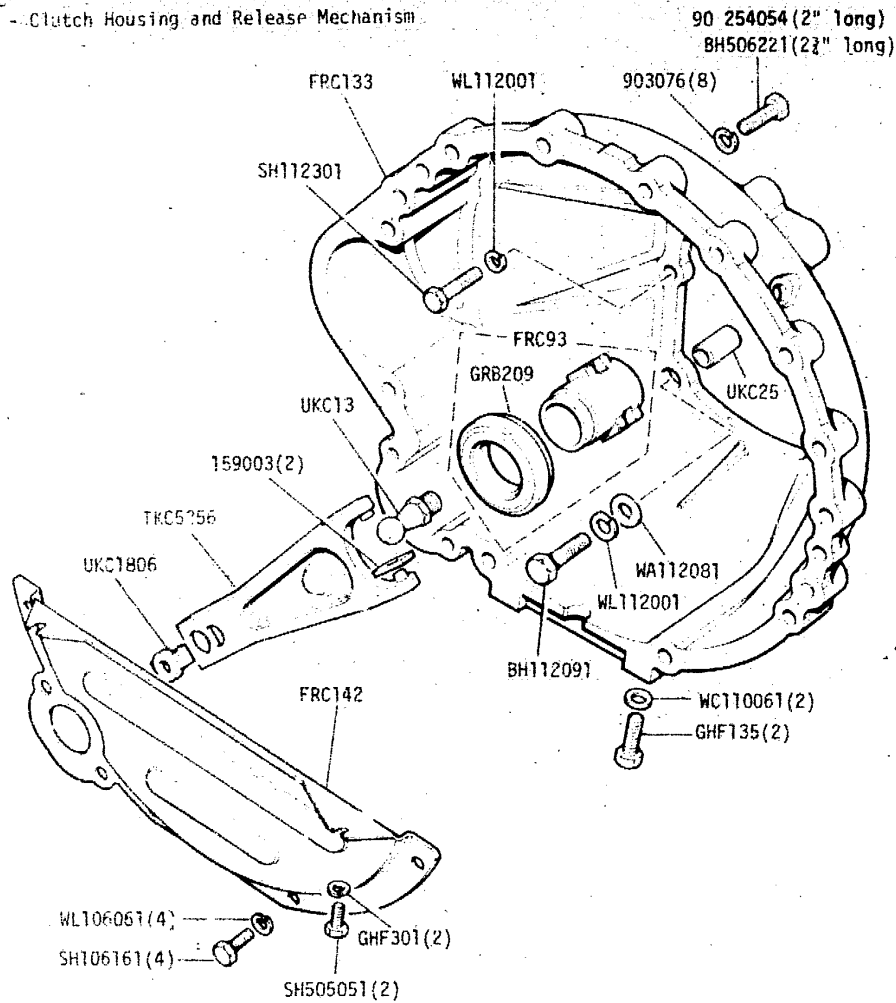

GROUP C
CLUTCH - Clutch Pedal and Mounting Bracket

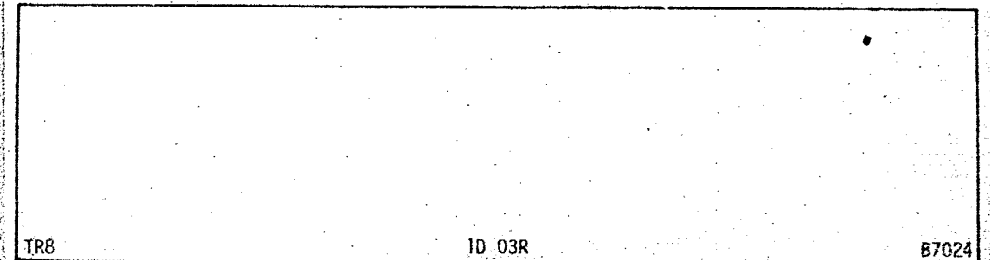
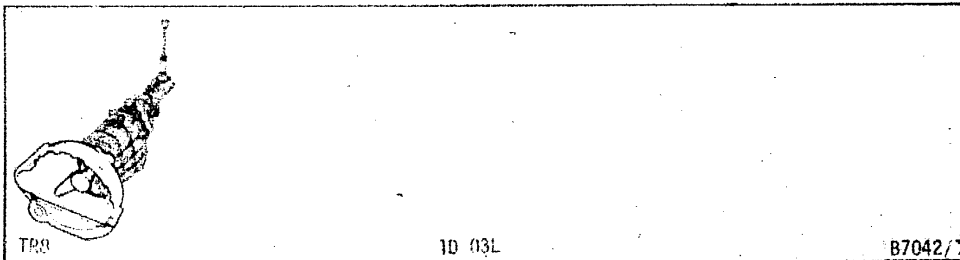
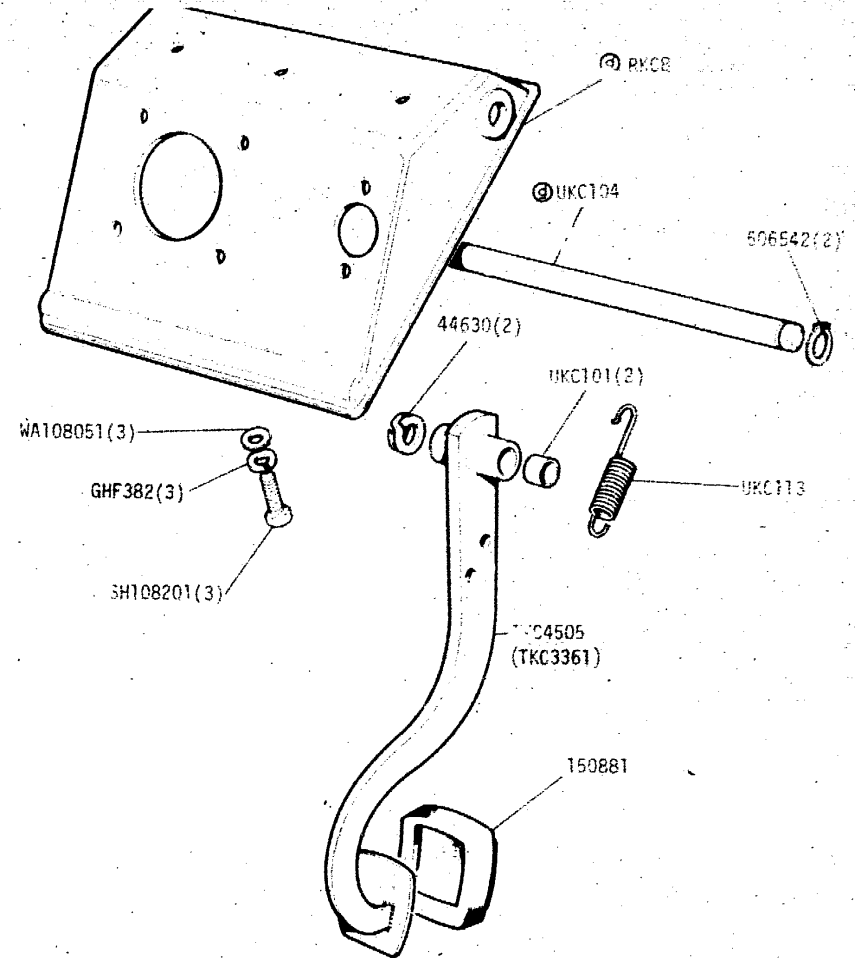

GROUP INDEX

Introduction **1B 2B**
 Engine **1C**
 Flywheel and Clutch **1D**
 Gearbox and Propshaft **1E**
 Axles, Suspension, Drive Shafts, Wheels **1F**

Steering **1G**
 Brakes and Brake Controls **1H**
 Fuel, Exhaust and Emission Systems **1I - J**
 Cooling, Heating and Air Conditioning **1K**
 Electrical, Washers-Wipers, Instruments **1L-M**

Chassis, Subframes, Bodyshell, Fittings **2C**
 Fascia, Trim, Seats and Fixings **2D**
 Miscellaneous **2E**
 Numerical Index **2F**

1D03

GROUP C
CLUTCH - Clutch Slave Cylinder

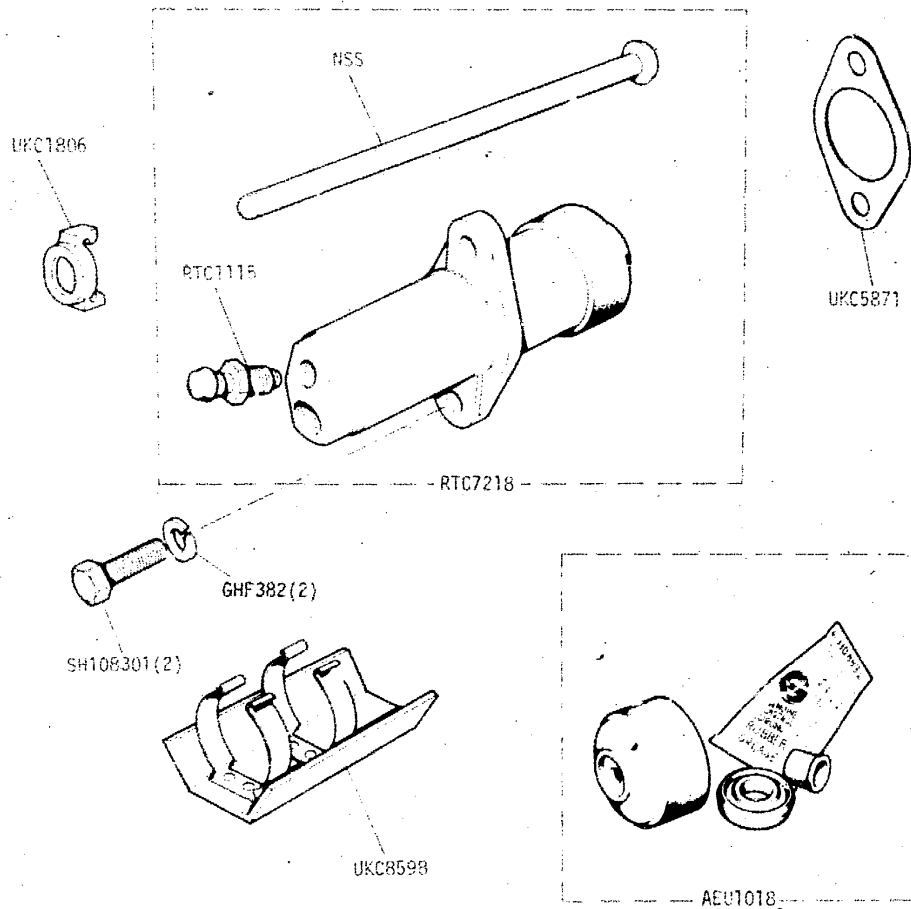

GROUP C
CLUTCH - Clutch Master Cylinder

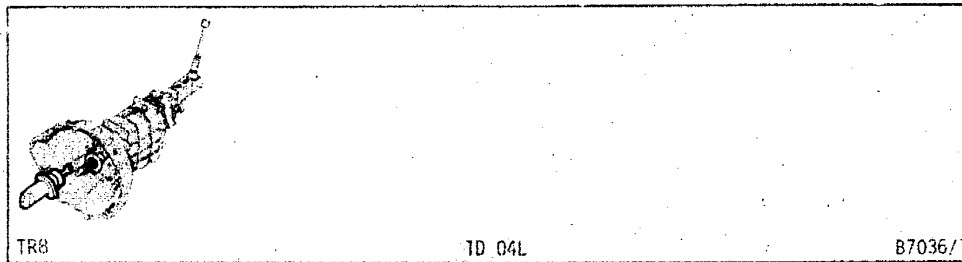
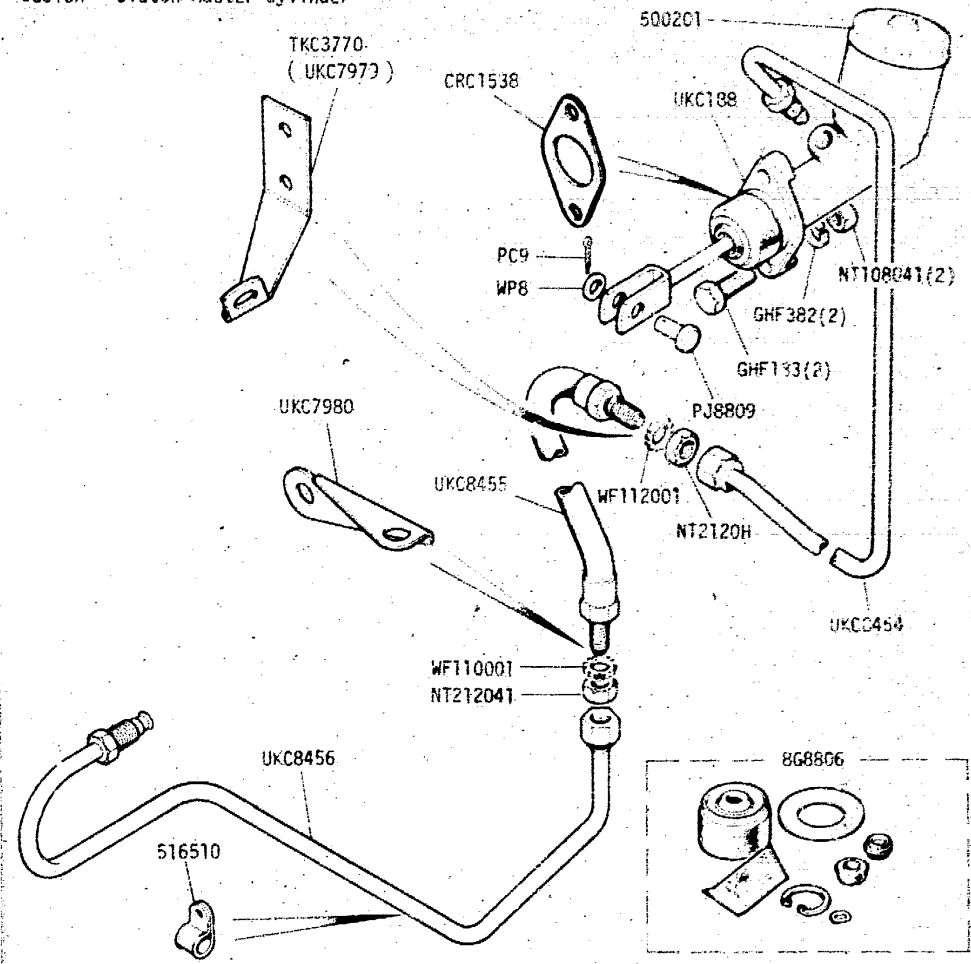

TD 04L

B7036/1

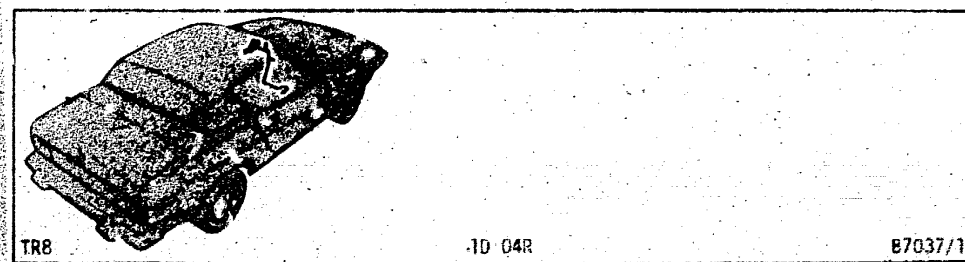

TD 04R

B7037/1

GROUP INDEX

Introduction **1B 2B**
 Engine **1C**
 Flywheel and Clutch **1D**
 Gearbox and Propshaft **1E**
 Axles, Suspension, Drive Shafts, Wheels **1F**

Steering **1G**
 Brakes and Brake Controls **1H**
 Fuel, Exhaust and Emission Systems **1I - J**
 Cooling, Heating and Air Conditioning **1K**
 Electrical, Washers-Wipers, Instruments **1L-M**

Chassis, Subframes, Bodyshell, Fittings **2C**
 Fascia, Trim, Seats and Fixings **2D**
 Miscellaneous **2E**
 Numerical Index **2F**

1D04